

LMV1015 Analog Series: Built-in Gain IC's for High Sensitivity 2-Wire Microphones

General Description

The LMV1015 is an audio amplifier series for small form factor electret microphones. This 2-wire portfolio is designed to replace the JFET amplifier. The LMV1015 series is ideally suited for applications requiring high signal integrity in the presence of ambient or RF noise, such as in cellular communications. The LMV1015 audio amplifiers are guaranteed to operate over a 2.2V to 5.0V supply voltage range with fixed gains of 15.6 dB and 23.8 dB. The devices offer excellent THD, gain accuracy and temperature stability as compared to a JFET microphone.

The LMV1015 series enables a two-pin electret microphone solution, which provides direct pin-to-pin compatibility with the existing older JFET market.

National Semiconductors built-in gain families are offered in extremely thin space saving 4-bump micro SMD packages (0.3 mm maximum). The LMV1015XR is designed for 1.0 mm ECM canisters and thicker. These extremely miniature packages have the Large Dome Bump (LDB) technology. This micro SMD technology is designed for microphone PCBs requiring 1 kg adhesion criteria.

Features

(Typical LMV1015-15, 2.2V supply, $R_L = 2.2\text{ k}\Omega$, $C = 2.2\text{ }\mu\text{F}$, $V_{IN} = 18\text{ mV}_{PP}$, unless otherwise specified)

- Supply voltage 2V - 5V
- Supply current <180 μA
- Signal to noise ratio (A-weighted) 60 dB
- Output voltage noise (A-weighted) -89 dBV
- Total harmonic distortion 0.09%
- Voltage gain
 - LMV1015-15 15.6 dB
 - LMV1015-25 23.8 dB
- Temperature range -40°C to 85°C
- Large Dome 4-Bump micro SMD package with improved adhesion technology.

Applications

- Cellular phones
- Headsets
- Mobile communications
- Automotive accessories
- PDAs
- Accessory microphone products

Schematic Diagram

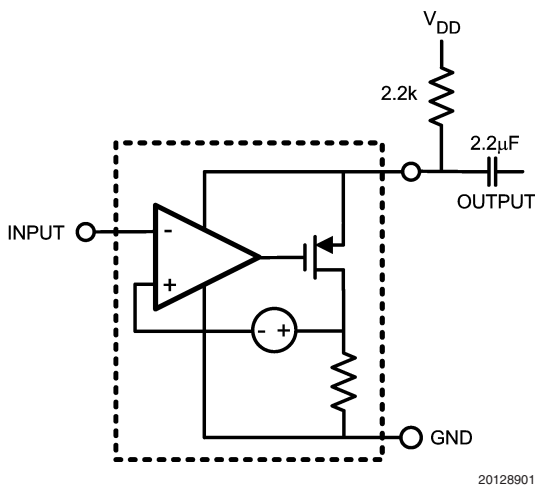

Built-In Gain Electret Microphone

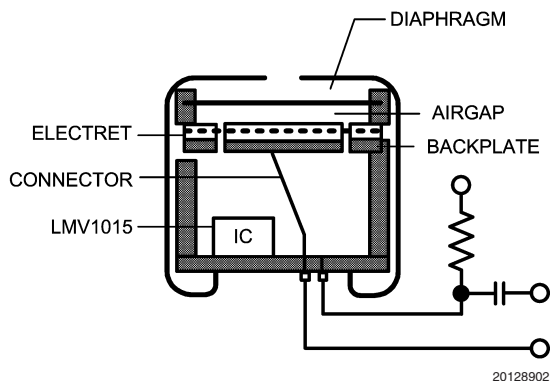

Absolute Maximum Ratings (Note 1)

If Military/Aerospace specified devices are required, please contact the National Semiconductor Sales Office/Distributors for availability and specifications.

ESD Tolerance (Note 2)	
Human Body Model	2500V
Machine Model	250V
Supply Voltage	
$V_{DD} - GND$	5.5V
Storage Temperature Range	-65°C to 150°C

Junction Temperature (Note 6)	150°C max
Mounting Temperature	
Infrared or Convection (20 sec.)	235°C

Operating Ratings (Note 1)

Supply Voltage	2V to 5V
Operating Temperature Range	-40°C to 85°C
Thermal Resistance (θ_{JA})	368°C/W

2.2V Electrical Characteristics (Note 3)

Unless otherwise specified, all limits guaranteed for $T_J = 25^\circ\text{C}$, $V_{DD} = 2.2\text{V}$, $V_{IN} = 18\text{ mV}_{PP}$, $R_L = 2.2\text{ k}\Omega$ and $C = 2.2\text{ }\mu\text{F}$. **Boldface** limits apply at the temperature extremes.

Symbol	Parameter	Conditions		Min (Note 4)	Typ (Note 5)	Max (Note 4)	Units
I_{DD}	Supply Current	$V_{IN} = GND$	LMV1015-15		180	300 325	μA
			LMV1015-25		141	250 300	
SNR	Signal to Noise Ratio	$f = 1\text{ kHz}$, $V_{IN} = 18\text{ mV}_{PP}$, A-Weighted	LMV1015-15		60		dB
			LMV1015-25		61		
V_{IN}	Max Input Signal	$f = 1\text{ kHz}$ and THD+N < 1%	LMV1015-15		100		mV_{PP}
			LMV1015-25		28		
V_{OUT}	Output Voltage	$V_{IN} = GND$	LMV1015-15	1.54 1.48	1.81	1.94 2.00	V
			LMV1015-25	1.65 1.49	1.90	2.02 2.18	
f_{LOW}	Lower -3dB Roll Off Frequency	$R_{SOURCE} = 50\Omega$			65		Hz
f_{HIGH}	Upper -3dB Roll Off Frequency	$R_{SOURCE} = 50\Omega$			95		kHz
e_n	Output Noise	A-Weighted	LMV1015-15		-89		dBV
			LMV1015-25		-82		
THD	Total Harmonic Distortion	$f = 1\text{ kHz}$, $V_{IN} = 18\text{ mV}_{PP}$	LMV1015-15		0.09		%
			LMV1015-25		0.15		
C_{IN}	Input Capacitance				2		pF
Z_{IN}	Input Impedance				>1000		$\text{G}\Omega$
A_V	Gain	$f = 1\text{ kHz}$, $R_{SOURCE} = 50\Omega$	LMV1015-15	14.0 13.1	15.6	16.9 17.5	dB
			LMV1015-25	22.5 21.4	23.8	25.0 25.7	

5V Electrical Characteristics (Note 3)

Unless otherwise specified, all limits guaranteed for $T_J = 25^\circ\text{C}$, $V_{DD} = 5\text{V}$, $V_{IN} = 18\text{ mV}_{PP}$, $R_L = 2.2\text{ k}\Omega$ and $C = 2.2\text{ }\mu\text{F}$. **Boldface** limits apply at the temperature extremes.

Symbol	Parameter	Conditions		Min (Note 4)	Typ (Note 5)	Max (Note 4)	Units
I_{DD}	Supply Current	$V_{IN} = GND$	LMV1015-15		200	300 325	μA
			LMV1015-25		160	250 300	

5V Electrical Characteristics (Note 3) (Continued)

Unless otherwise specified, all limits guaranteed for $T_J = 25^\circ\text{C}$, $V_{DD} = 5\text{V}$, $V_{IN} = 18\text{ mV}_{PP}$, $R_L = 2.2\text{ k}\Omega$ and $C = 2.2\text{ }\mu\text{F}$.

Boldface limits apply at the temperature extremes.

Symbol	Parameter	Conditions	Min (Note 4)	Typ (Note 5)	Max (Note 4)	Units
SNR	Signal to Noise Ratio	$f = 1\text{ kHz}$, $V_{IN} = 18\text{ mV}_{PP}$, A-Weighted	LMV1015-15		60	dB
			LMV1015-25		61	
V_{IN}	Max Input Signal	$f = 1\text{ kHz}$ and THD+N < 1%	LMV1015-15		100	mV_{PP}
			LMV1015-25		28	
V_{OUT}	Output Voltage	$V_{IN} = \text{GND}$	LMV1015-15	4.34 4.28	4.56 4.80	V
			LMV1015-25	4.45 4.39	4.65 4.86	
f_{LOW}	Lower -3dB Roll Off Frequency	$R_{SOURCE} = 50\Omega$		67		Hz
f_{HIGH}	Upper -3dB Roll Off Frequency	$R_{SOURCE} = 50\Omega$		150		kHz
e_n	Output Noise	A-Weighted	LMV1015-15		-89	dBV
			LMV1015-25		-82	
THD	Total Harmonic Distortion	$f = 1\text{ kHz}$, $V_{IN} = 18\text{ mV}_{PP}$	LMV1015-15		0.13	%
			LMV1015-25		0.21	
C_{IN}	Input Capacitance			2		pF
Z_{IN}	Input Impedance			>1000		$\text{G}\Omega$
A_V	Gain	$f = 1\text{ kHz}$, $R_{SOURCE} = 50\Omega$	LMV1015-15	14.0 13.1	15.6 17.5	dB
			LMV1015-25	22.5 21.2	23.9 25.1	

Note 1: Absolute Maximum Ratings indicate limits beyond which damage to the device may occur. Operating Ratings indicate conditions for which the device is intended to be functional, but specific performance is not guaranteed. For guaranteed specifications and the test conditions, see the Electrical Characteristics.

Note 2: Human Body Model (HBM) is 1.5 k Ω in series with 100 pF.

Note 3: Electrical Table values apply only for factory testing conditions at the temperature indicated. Factory testing conditions result in very limited self-heating of the device such that $T_J = T_A$. No guarantee of parametric performance is indicated in the electrical tables under conditions of internal self-heating where $T_J > T_A$.

Note 4: All limits are guaranteed by design or statistical analysis.

Note 5: Typical values represent the most likely parametric norm.

Note 6: The maximum power dissipation is a function of $T_{J(MAX)}$, θ_{JA} and T_A . The maximum allowable power dissipation at any ambient temperature is $P_D = (T_{J(MAX)} - T_A)/\theta_{JA}$. All numbers apply for packages soldered directly into a PC board.

Connection Diagram

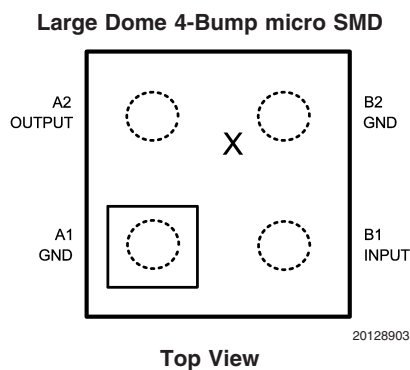

Note: - Pin numbers are referenced to package marking text orientation.
 - The actual physical placement of the package marking will vary slightly from part to part. The package will designate the date code and will vary considerably. Package marking does not correlate to device type in any way.

Ordering Information

Package	Part Number	Package Marking	Transport Media	NSC Drawing
4-Bump Extreme Thin micro SMD (0.3 mm max height) lead free only	LMV1015XR-15	Date Code	250 Units Tape and Reel	XRA04ADA
	LMV1015XR-15		3k Units Tape and Reel	
	LMV1015XR-25		250 Units Tape and Reel	
	LMV1015XR-25		3k Units Tape and Reel	
4-Bump Ultra-Thin micro SMD (0.4 mm max height) lead free only	LMV1015UR-15	Date Code	250 Units Tape and Reel	URA04ADA
	LMV1015UR-15		3k Units Tape and Reel	
	LMV1015UR-25		250 Units Tape and Reel	
	LMV1015UR-25		3k Units Tape and Reel	

Note: All packages are supplied with large dome bump technology for 1kg adhesion criteria.

Typical Performance Characteristics

Unless otherwise specified, $V_S = 2.2V$, $R_L = 2.2 k\Omega$,

$C = 2.2 \mu F$, single supply, $T_A = 25^\circ C$

Supply Current vs. Supply Voltage (LMV1015-15)

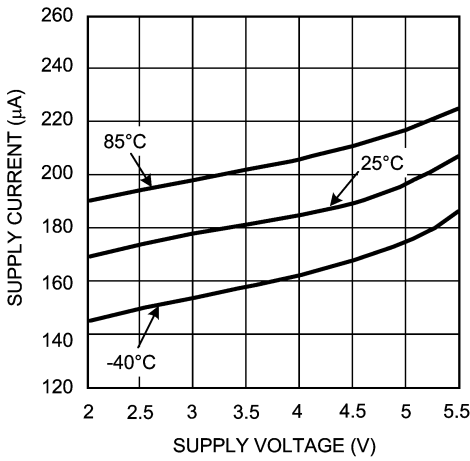

20128904

Supply Current vs. Supply Voltage (LMV1015-25)

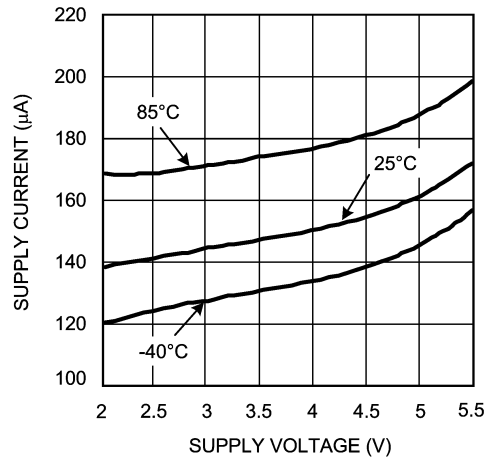

20128919

Gain and Phase vs. Frequency (LMV1015-15)

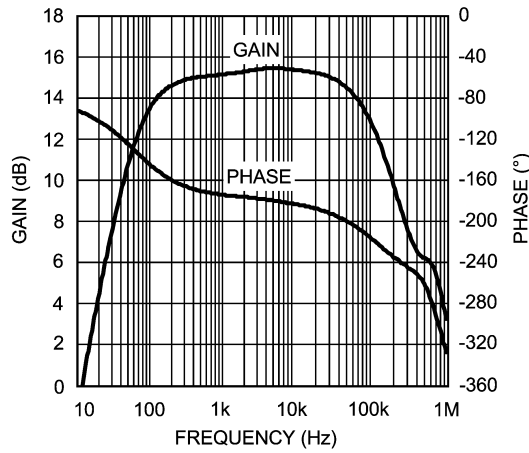

20128905

Gain and Phase vs. Frequency (LMV1015-25)

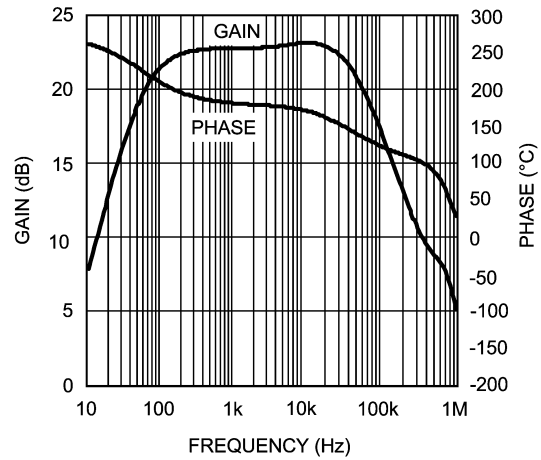

20128913

Total Harmonic Distortion vs. Frequency (LMV1015-15)

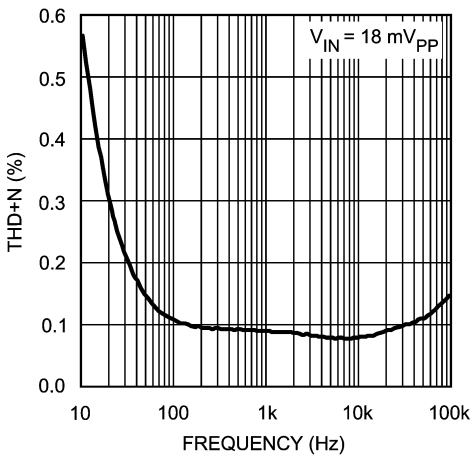

20128906

Total Harmonic Distortion vs. Frequency (LMV1015-25)

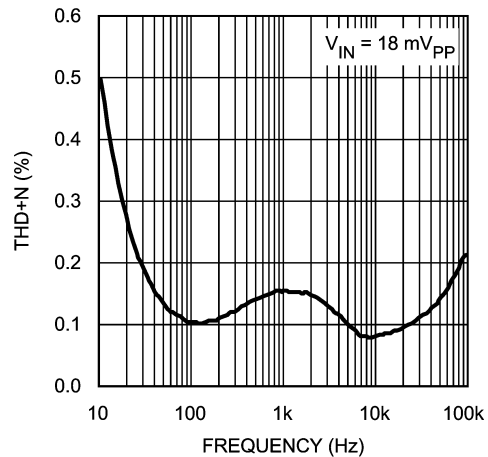

20128921

Typical Performance Characteristics Unless otherwise specified, $V_S = 2.2V$, $R_L = 2.2 k\Omega$, $C = 2.2 \mu F$, single supply, $T_A = 25^\circ C$ (Continued)

Total Harmonic Distortion vs. Input Voltage (LMV1015-15)

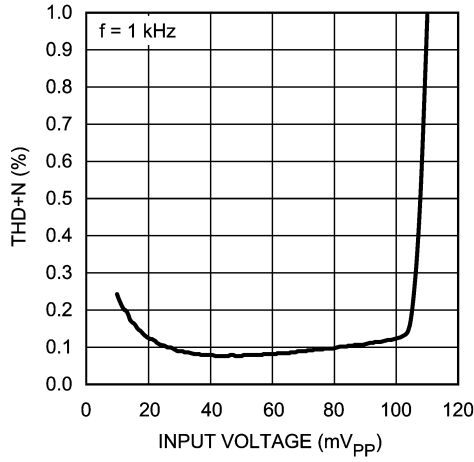

20128907

Total Harmonic Distortion vs. Input Voltage (LMV1015-25)

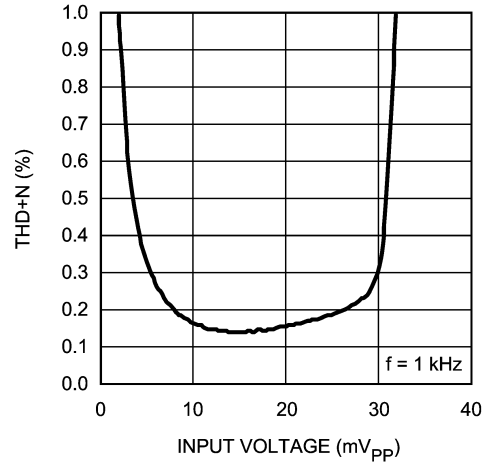

20128923

Output Noise vs. Frequency (LMV1015-15)

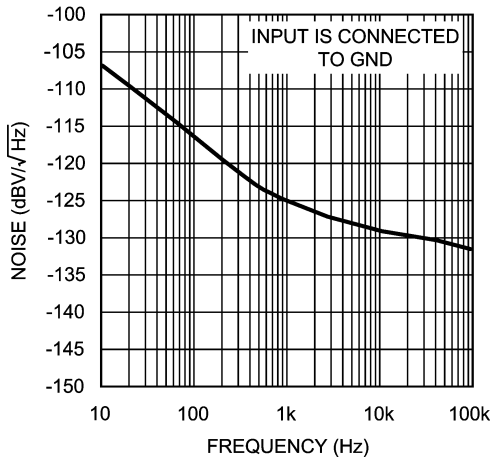

20128915

Output Noise vs. Frequency (LMV1015-25)

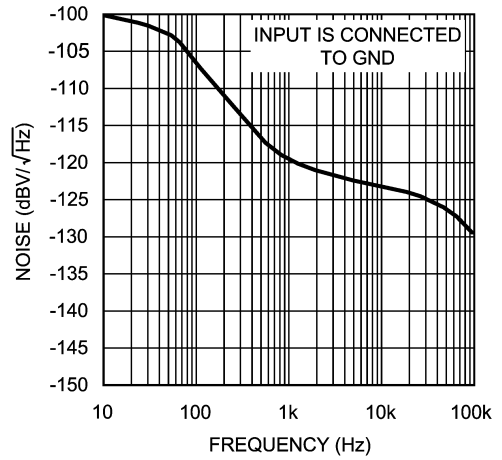

20128916

Application Section

HIGH GAIN

The LMV1015 series provides outstanding gain versus the JFET and still maintains the same ease of implementation, with improved gain, linearity and temperature stability. A high gain eliminates the need for extra external components.

BUILT IN GAIN

The LMV1015 is offered in 0.3 mm height space saving small 4-pin micro SMD packages in order to fit inside the different size ECM canisters of a microphone. The LMV1015 is placed on the PCB inside the microphone using Large Dome Bump technology (LDB).

The bottom side of the PCB usually shows a bull's eye pattern where the outer ring, which is shorted to the metal can, should be connected to the ground. The center dot on the PCB is connected to the V_{DD} through a resistor. This phantom biasing allows both supply voltage and output signal on one connection.

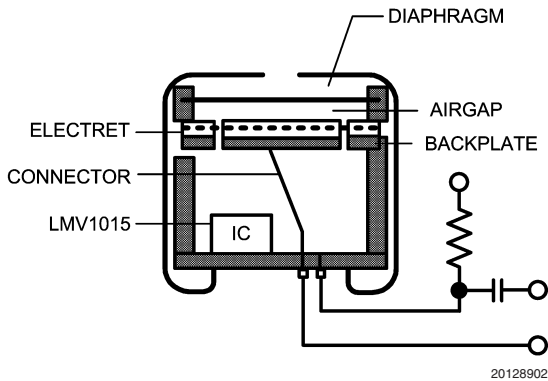

FIGURE 1. Built in Gain

A-WEIGHTED FILTER

The human ear has a frequency range from 20 Hz to about 20 kHz. Within this range the sensitivity of the human ear is not equal for each frequency. To approach the hearing response weighting filters are introduced. One of those filters is the A-weighted filter.

The A-weighted filter is usually used in signal to noise ratio measurements, where sound is compared to device noise. This filter improves the correlation of the measured data to the signal to noise ratio perceived by the human ear.

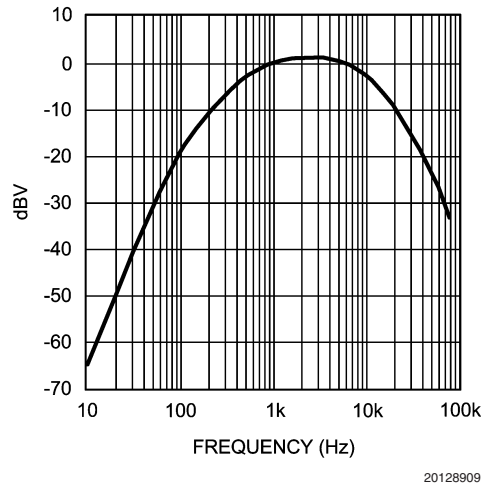

FIGURE 2. A-Weighted Filter

MEASURING NOISE AND SNR

The overall noise of the LMV1015 is measured within the frequency band from 10 Hz to 22 kHz using an A-weighted filter. The input of the LMV1015 is connected to ground with a 5 pF capacitor, as in Figure 3. Special precautions in the internal structure of the LMV1015 have been taken to reduce the noise on the output.

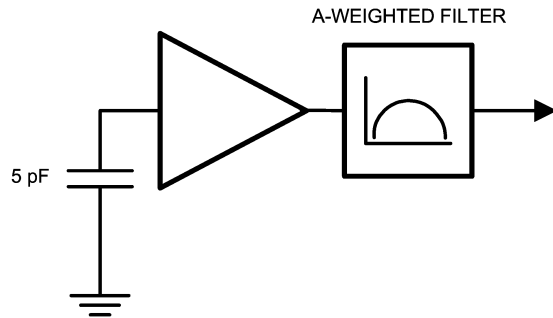

FIGURE 3. Noise Measurement Setup

The signal to noise ratio (SNR) is measured with a 1 kHz input signal of 18 mV_{PP} using an A-weighted filter. This represents a sound pressure level of 94 dB SPL. No input capacitor is connected for the measurement.

SOUND PRESSURE LEVEL

The volume of sound applied to a microphone is usually stated as a pressure level referred to the threshold of hearing of the human ear. The sound pressure level (SPL) in decibels is defined by:

$$\text{Sound pressure level (dB)} = 20 \log P_m/P_o$$

Where,

P_m is the measured sound pressure

P_o is the threshold of hearing (20 μ Pa)

In order to be able to calculate the resulting output voltage of the microphone for a given SPL, the sound pressure in dB

Application Section (Continued)

SPL needs to be converted to the absolute sound pressure in dBPa. This is the sound pressure level in decibels referred to 1 Pascal (Pa).

The conversion is given by:

$$\text{dBPa} = \text{dB SPL} + 20 \cdot \log 20 \mu\text{Pa}$$

$$\text{dBPa} = \text{dB SPL} - 94 \text{ dB}$$

Translation from absolute sound pressure level to a voltage is specified by the sensitivity of the microphone. A conventional microphone has a sensitivity of -44 dBV/Pa.

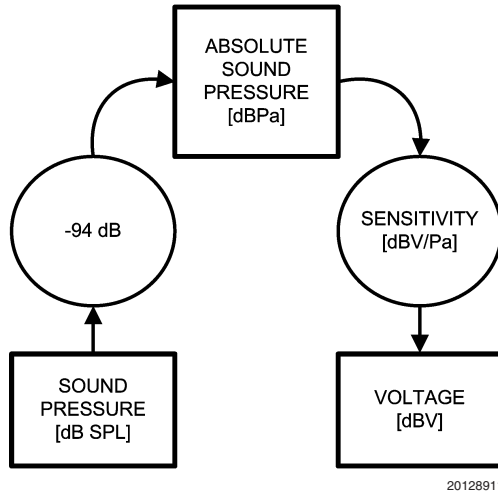

FIGURE 4. dB SPL to dBV Conversion

Example: Busy traffic is 70 dB SPL

$$V_{\text{OUT}} = 70 - 94 - 44 = -68 \text{ dBV}$$

This is equivalent to 1.13 mV_{PP}

Since the LMV1015-15 has a gain of 6 (15.6 dB) over the JFET, the output voltage of the microphone is 6.78 mV_{PP}. By implementing the LMV1015-15, the sensitivity of the microphone is -28.4 dBV/Pa (-44 + 15.6).

LOW FREQUENCY CUT OFF FILTER

To reduce noise on the output of the microphone a low frequency cut off filter has been implemented. This filter reduces the effect of wind and handling noise.

It's also helpful to reduce the proximity effect in directional microphones. This effect occurs when the sound source is very close to the microphone. The lower frequencies are

amplified which gives a bass sound. This amplification can cause an overload, which results in a distortion of the signal.

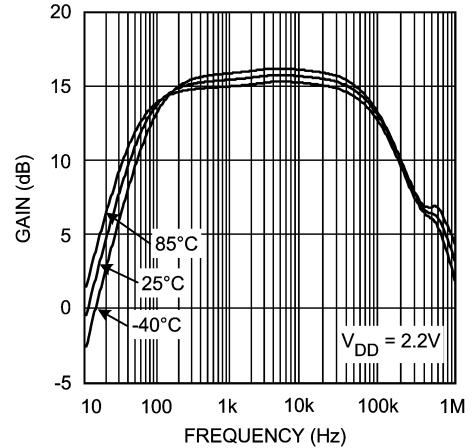

FIGURE 5. LMV1015-15 Gain vs. Frequency Over Temperature

The LMV1015 is optimized to be used in audio band applications. By using the LMV1015, the gain response is flat within the audio band and has linearity and temperature stability *Figure 5*.

NOISE

Noise pick-up by a microphone in cell phones is a well-known problem. A conventional JFET circuit is sensitive for noise pick-up because of its high output impedance, which is usually around 2.2 kΩ.

RF noise is amongst other caused by non-linear behavior. The non-linear behavior of the amplifier at high frequencies, well above the usable bandwidth of the device, causes AM-demodulation of high frequency signals. The AM modulation contained in such signals folds back into the audio band, thereby disturbing the intended microphone signal. The GSM signal of a cell phone is such an AM-modulated signal. The modulation frequency of 216 Hz and its harmonics can be observed in the audio band. This kind of noise is called bumblebee noise.

RF noise caused by a GSM signal can be reduced by connecting two external capacitors to ground, see *Figure 6*. One capacitor reduces the noise caused by the 900 MHz carrier and the other reduces the noise caused by 1800/1900 MHz.

Application Section (Continued)

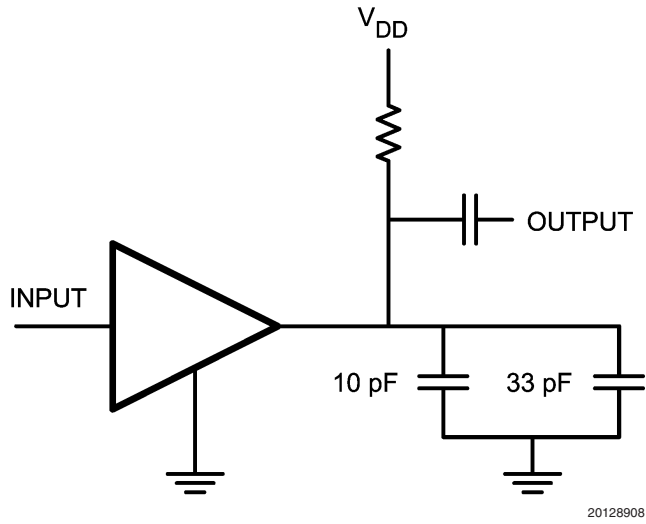
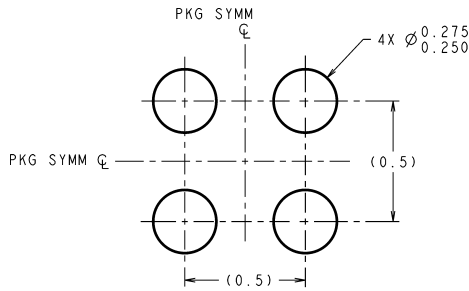

FIGURE 6. RF Noise Reduction

Physical Dimensions inches (millimeters) unless otherwise noted



DIMENSIONS ARE IN MILLIMETERS
DIMENSIONS IN () FOR REFERENCE ONLY

LAND PATTERN RECOMMENDATION

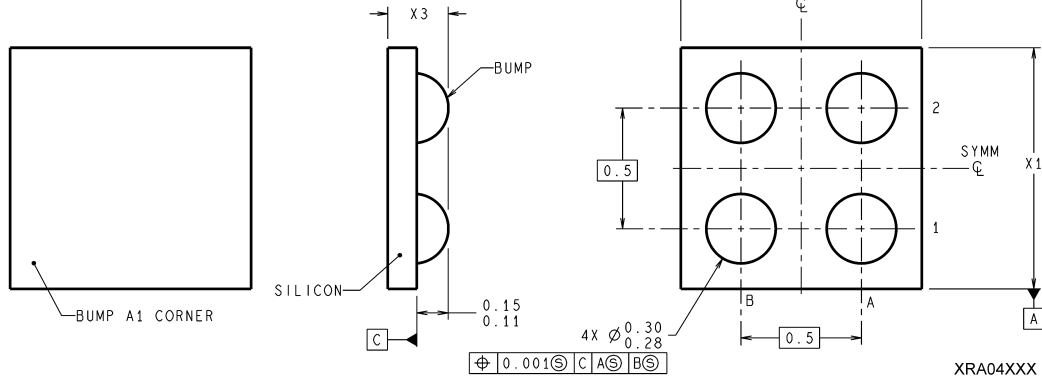

XRA04XXX (Rev A)

NOTE: UNLESS OTHERWISE SPECIFIED.

1. FOR SOLDER BUMP COMPOSITION, SEE "SOLDER INFORMATION" IN THE PACKAGING SECTION OF THE NATIONAL SEMICONDUCTOR WEB PAGE (www.national.com).
2. RECOMMEND NON-SOLDER MASK DEFINED LANDING PAD.
3. PIN A1 IS ESTABLISHED BY LOWER LEFT CORNER WITH RESPECT TO TEXT ORIENTATION.
4. XXX IN DRAWING NUMBER REPRESENTS PACKAGE SIZE VARIATION WHERE X1 IS PACKAGE WIDTH, X2 IS PACKAGE LENGTH AND X3 IS PACKAGE HEIGHT.
5. REFERENCE JEDEC REGISTRATION MO-211. VARIATION CA.

**4-Bump Extreme Thin micro SMD with Large Dome Bump Technology
NS Package Number XRA04ADA**

$X_1 = 0.975 \text{ mm}$ $X_2 = 1.051 \text{ mm}$ $X_3 = 0.300 \text{ mm}$

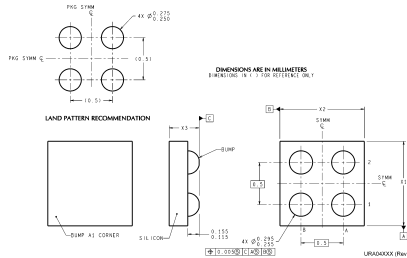

NOTE: UNLESS OTHERWISE SPECIFIED.

1. FOR SOLDER BUMP COMPOSITION, SEE "SOLDER INFORMATION" IN THE PACKAGING SECTION OF THE NATIONAL SEMICONDUCTOR WEB PAGE (www.national.com).
2. RECOMMEND NON-SOLDER MASK DEFINED LANDING PAD.
3. PIN A1 IS ESTABLISHED BY LOWER LEFT CORNER WITH RESPECT TO TEXT ORIENTATION.
4. XXX IN DRAWING NUMBER REPRESENTS PACKAGE SIZE VARIATION WHERE X1 IS PACKAGE WIDTH, X2 IS PACKAGE LENGTH AND X3 IS PACKAGE HEIGHT.
5. NO JEDEC REGISTRATION AS OF March 2005.

**4-Bump ULTRA-Thin micro SMD with Large Dome Bump Technology
NS Package Number URA04ADA**

$X_1 = 0.975 \text{ mm}$ $X_2 = 1.051 \text{ mm}$ $X_3 = 0.400 \text{ mm}$

Notes

National does not assume any responsibility for use of any circuitry described, no circuit patent licenses are implied and National reserves the right at any time without notice to change said circuitry and specifications.
 For the most current product information visit us at www.national.com.

LIFE SUPPORT POLICY

NATIONAL'S PRODUCTS ARE NOT AUTHORIZED FOR USE AS CRITICAL COMPONENTS IN LIFE SUPPORT DEVICES OR SYSTEMS WITHOUT THE EXPRESS WRITTEN APPROVAL OF THE PRESIDENT AND GENERAL COUNSEL OF NATIONAL SEMICONDUCTOR CORPORATION. As used herein:

- | | |
|--|---|
| <p>1. Life support devices or systems are devices or systems which, (a) are intended for surgical implant into the body, or (b) support or sustain life, and whose failure to perform when properly used in accordance with instructions for use provided in the labeling, can be reasonably expected to result in a significant injury to the user.</p> | <p>2. A critical component is any component of a life support device or system whose failure to perform can be reasonably expected to cause the failure of the life support device or system, or to affect its safety or effectiveness.</p> |
|--|---|

BANNED SUBSTANCE COMPLIANCE

National Semiconductor manufactures products and uses packing materials that meet the provisions of the Customer Products Stewardship Specification (CSP-9-111C2) and the Banned Substances and Materials of Interest Specification (CSP-9-111S2) and contain no "Banned Substances" as defined in CSP-9-111S2.

Leadfree products are RoHS compliant.



National Semiconductor
Americas Customer
Support Center
 Email: new.feedback@nsc.com
 Tel: 1-800-272-9959

National Semiconductor
Europe Customer Support Center
 Fax: +49 (0) 180-530 85 86
 Email: europe.support@nsc.com
 Deutsch Tel: +49 (0) 69 9508 6208
 English Tel: +44 (0) 870 24 0 2171
 Français Tel: +33 (0) 1 41 91 8790

National Semiconductor
Asia Pacific Customer
Support Center
 Email: ap.support@nsc.com

National Semiconductor
Japan Customer Support Center
 Fax: 81-3-5639-7507
 Email: jpn.feedback@nsc.com
 Tel: 81-3-5639-7560